



Symaro™

Duct Temperature Sensors

QAM2161.040
QAM2171.040

- Active sensors for acquiring the air temperature in air ducts
- Operating voltage AC 24 V or DC 13.5...35 V
- Signal output DC 0...10 V or 4...20 mA

Use

The QAM... duct temperature sensors are for use in ventilation and air conditioning plants as:

- Supply or extract air temperature sensors
- Limit sensors, e.g. for minimum limitation of the supply air temperature
- Reference sensors, e.g. for compensation of the room temperature as a function of the outside temperature
- Dew point temperature sensors
- Measuring sensors, e.g. for measured value indication or for connection to a building automation and control system

Type summary

Type reference	Probe length	Measuring range	Operating voltage	Output signal
QAM2161.040	0.4 m	-50...+50 °C	AC 24 V ±20 % / DC 13.5...35 V	DC 0...10 V
QAM2171.040	0.4 m	-50...+50 °C	DC 13.5...35 V	4...20 mA

Ordering and delivery

When ordering, please give name and type reference, e.g.:

Duct temperature sensor **QAM2161.040**

The sensor is supplied complete with mounting flange AQM63.0 and cable entry gland M16.

Equipment combinations

All systems or devices capable of acquiring and handling the sensor's DC 0...10 V or 4...20 mA output signal.

Function

The sensor acquires the air temperature via its sensing element whose resistance value changes as a function of the temperature. This change is converted to a DC 0...10 V or 4...20 mA output signal, depending on the type of sensor. The output signal corresponds to the selected temperature range.

Burden diagram

Output signal, terminal I1

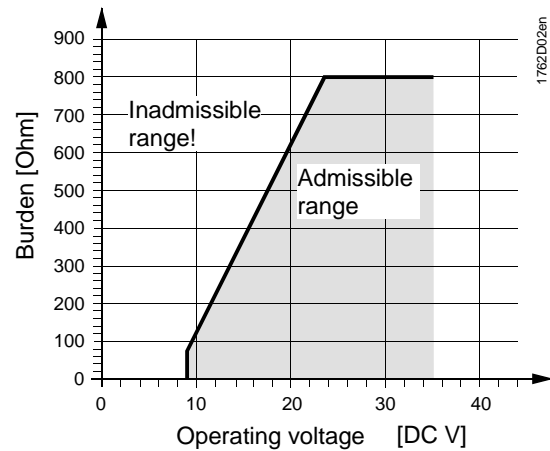

Mechanical design

The duct temperature sensor consists of housing, printed circuit board, connection terminals and probe. The 2-sectional housing is comprised of base and removable cover (snap-on design). The measuring circuit and the setting element are located on the printed circuit board inside the cover, the connection terminals on the base. Cable entry is made via the M16 cable entry gland (IP 54) supplied with the sensor which can be screwed into the housing. Probe and housing are rigidly connected. The sensor is designed for screwed or flanged mounting. It can be fitted as follows:

- With the mounting flange supplied with the sensor (recommended), which is to be fitted to the sensor and then secured in accordance with the required immersion length, or
- Without mounting flange (making use of the maximum immersion length). For that propose, the housing has 4 holes for fitting the sensor directly to the air duct

Setting element

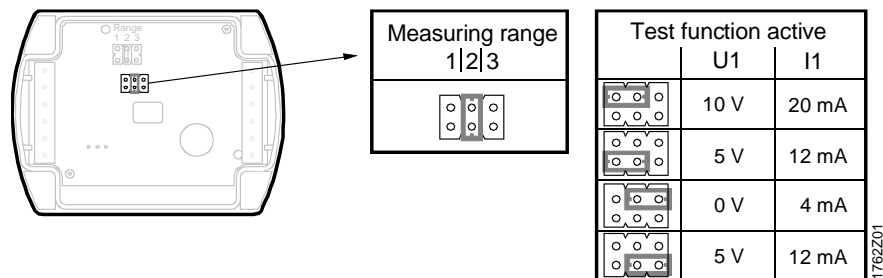

The setting element is located inside the cover. It consists of 6 pins and a shorting plug. It is used to select the required measuring range and to activate the test function.

The different plug positions have the following meaning

- *For the temperature measuring range:*
 Shorting plug in the left position (R1) = 0...50 °C
 Shorting plug in the mid position (R2) = -50...+50 °C (factory setting)
 Shorting plug in the right position (R3) = -35...+35 °C
- *For activating the test function:*
 Shorting plug in the horizontal position: The values according to the table "Test function active" will be made available at the signal output.

Fault In the event of fault, the output signal will reach 0 V (4 mA) after 60 seconds.

Engineering notes

To power the sensor, a transformer for safety extra low-voltage (SELV) with separate windings for 100 % duty is required. When sizing and electrically protecting the transformer, local safety regulations must be observed.

When sizing the transformer, the power consumption of the temperature sensor must be taken into consideration. For correct wiring, refer to the Data Sheets of the devices with which the sensor is used.

The permissible cable lengths must be observed.

Cable routing and cable selection

When laying the cables, it must be observed that the longer the cables run side by side and the smaller the distance between them, the greater the electrical interference. Twisted pair cables are required for the secondary supply lines and the signal lines.

Mounting notes

Mounting location

- *For supply air temperature control:* Downstream from the fan, if the fan is located after the last air handling unit. Otherwise, after the last air handling unit with a minimum distance of 0.5 m
- *For extract air temperature control:* Always upstream of the extract air fan
- *As a limit sensor for the supply air temperature:* As close as possible to the air outlet into the room
- *For dew point control:* Immediately after the spray trap of the air washer

Manually bend the probe so that it lies diagonally across the duct or in equally spaced windings across the entire duct cross-section. The probe must not touch the duct wall. Mounting Instructions are printed on the packaging.

Mounting positions

Permitted:



Not permitted:



Mounting examples

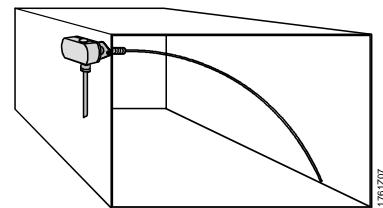
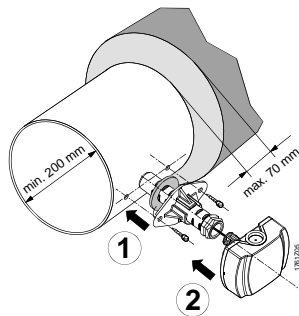

Disposal



The devices are considered electronics devices for disposal in term of European Directive 2012/19/EU and may not be disposed of as domestic waste.

- Dispose of the device via the channels provided for this purpose.
- Comply with all local and currently applicable laws and regulations.

Technical data

Power supply	Power supply	Safety extra-low voltage (SELV)
	Operating voltage (QAM2161.040)	AC 24 V \pm 20%, or DC 13.5...35 V or AC/DC 24 V class 2 (US)
	Operating voltage (QAM2171.040)	DC 13.5...35 V or DC 24 V class 2 (US)
	Frequency	50/60 Hz at AC 24 V
	External supply line protection (EU)	Fuse slow max. 10 A or Circuit breaker max. 13 A Characteristic B, C, D according to EN 60898 or Power source with current limitation of max. 10 A
	Power consumption	\leq 1 VA
Line lengths for measuring signal	Perm. cable lengths	
	Copper cable 0.6 mm dia.	50 m
	Copper cable 1 mm ²	150 m
	Copper cable 1.5 mm ²	300 m
Functional data	Measuring range	-50...+50 °C (R2 = factory setting), 0...50 °C (R1), -35...+35 °C (R3)
	Probe	
	Probe length	0.4 m
	Minimum bending radius	10 mm
	Sensing element	Pt 1000
	Time constant	30 s at 2 m/s
	Dead time	<1 s
	Measuring accuracy in the range of	
	-25...+25 °C	\pm 0.75 K
	-50...+50 °C	\pm 0.9 K
	Output signal, linear (terminal U1)	DC 0...10 V $\hat{=}$ -50...+50 °C or -35...+35 °C or 0...50 °C, max. \pm 1 mA
	Output signal, linear (terminal I1)	4...20 mA $\hat{=}$ -50...+50 °C or -35...+35 °C or 0...50 °C
	Burden	refer to "Function"
Degree of protection	Protection degree of housing	IP54 according to EN 60529
	Protection class	III according to EN 60730-1
Electrical connections	Connection terminals for	1 x 2.5 mm ² or 2 x 1.5 mm ²
	Cable entry gland (enclosed)	M 16 x 1.5
Environmental conditions	Operation	IEC 721-3-3
	Climatic conditions	class 3K5
	Temperature (housing)	-40...+70 °C
	Humidity (housing)	5...95 % r. h.
	Transport	IEC 721-3-2
	Climatic conditions	class 2K3
	Temperature	-25...+70 °C
Humidity	<95 % r. h.	
	Mechanical conditions	class 2M2

Materials and colors	Probe	copper, polyolefine
	Base	polycarbonate, RAL 7001 (silver-grey)
	Cover	polycarbonate, RAL 7035 (light-grey)
	Mounting flange	PA 66 (black)
	Cable entry gland	PA, RAL 7035 (light-grey)
	Packaging	corrugated cardboard
Directives and Standards	Product standard	EN 60730-1 Automatic electrical controls for household and similar use
	EU Conformity (CE)	CET1762xx ^{*)}
	RCM Conformity	CE1T1864en_C1 ^{*)}
	UL	UL 873, http://ul.com/database
Environmental compatibility	The product environmental declaration CE1E1762 ^{*)} contains data on environmentally compatible product design and assessments (RoHS compliance, materials composition, packaging, environmental benefit, disposal).	
Weight	Incl. packaging	
	QAM2161.040	approx. 0.17 kg
	QAM2171.040	approx. 0.17 kg
*) The documents can be downloaded from http://siemens.com/bt/download .		

Connection terminals

QAM2161.040

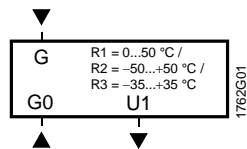

QAM2171.040

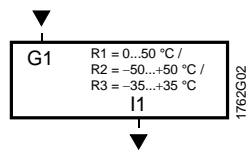

- G, G0 Operating voltage AC 24 V (SELV) or DC 13.5...35 V
- G1 Operating voltage DC 13.5...35 V
- I1 Signal output 4...20 mA
for measuring range -50...+50 °C (factory setting), 0...50 °C or -35...+35 °C
- U1 Signal output DC 0...10 V
for measuring range -50...+50 °C (factory setting), 0...50 °C or -35...+35 °C

Dimensions

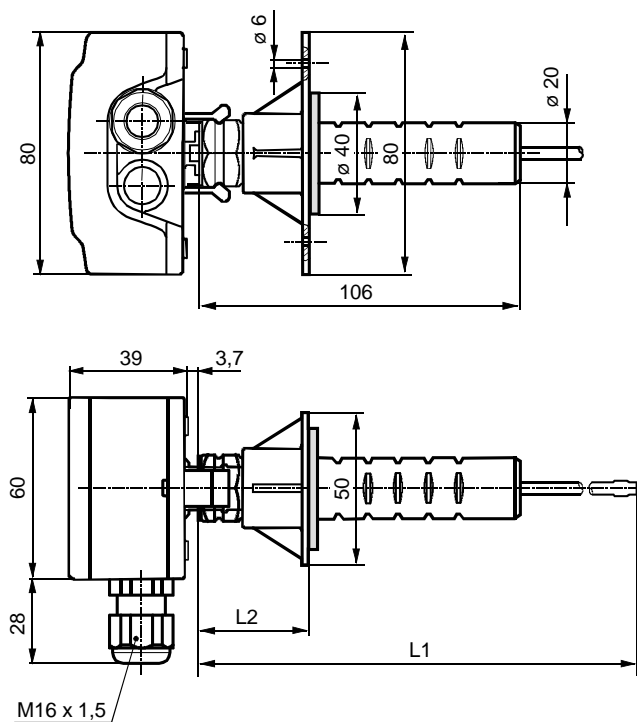

Typ	L1	L2	
		max.	min.
QAM2161.040	400	97	37
QAM2171.040	400	97	37

Dimensions in mm